

# Multi-Dimensional Simulation of Flows Inside Polydisperse Packed Beds

*R. Gregory Schunk<sup>1</sup>, Karen Son<sup>2</sup>, James C. Knox<sup>1</sup>  
and Robert F. Coker<sup>1</sup>*

*Advanced Exploration/Life Support Systems Project  
NASA Marshall Space Flight Center*

**COMSOL  
CONFERENCE**  
2015 BOSTON

<sup>1</sup> NASA/MSFC

<sup>2</sup> NSTR Fellow, Purdue University

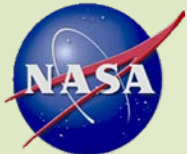

# Introduction

- An analysis to quantify the effects of packed bed channeling in the narrow passages of the ISS (International Space Station) CDRA (Carbon Dioxide Removal Assembly) on heat transfer and pressure drop is presented.
- The small size of a single CDRA adsorbent bed channel provides a unique opportunity to directly attack this low Reynolds number, three dimensional flow problem with the pellet geometry immersed in the flow field formed by the bounding channel heater and fin walls.
- Results from the 3D simulation for random bed packing's are presented.

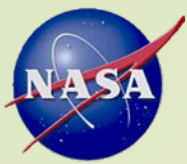

# Channeling Effect

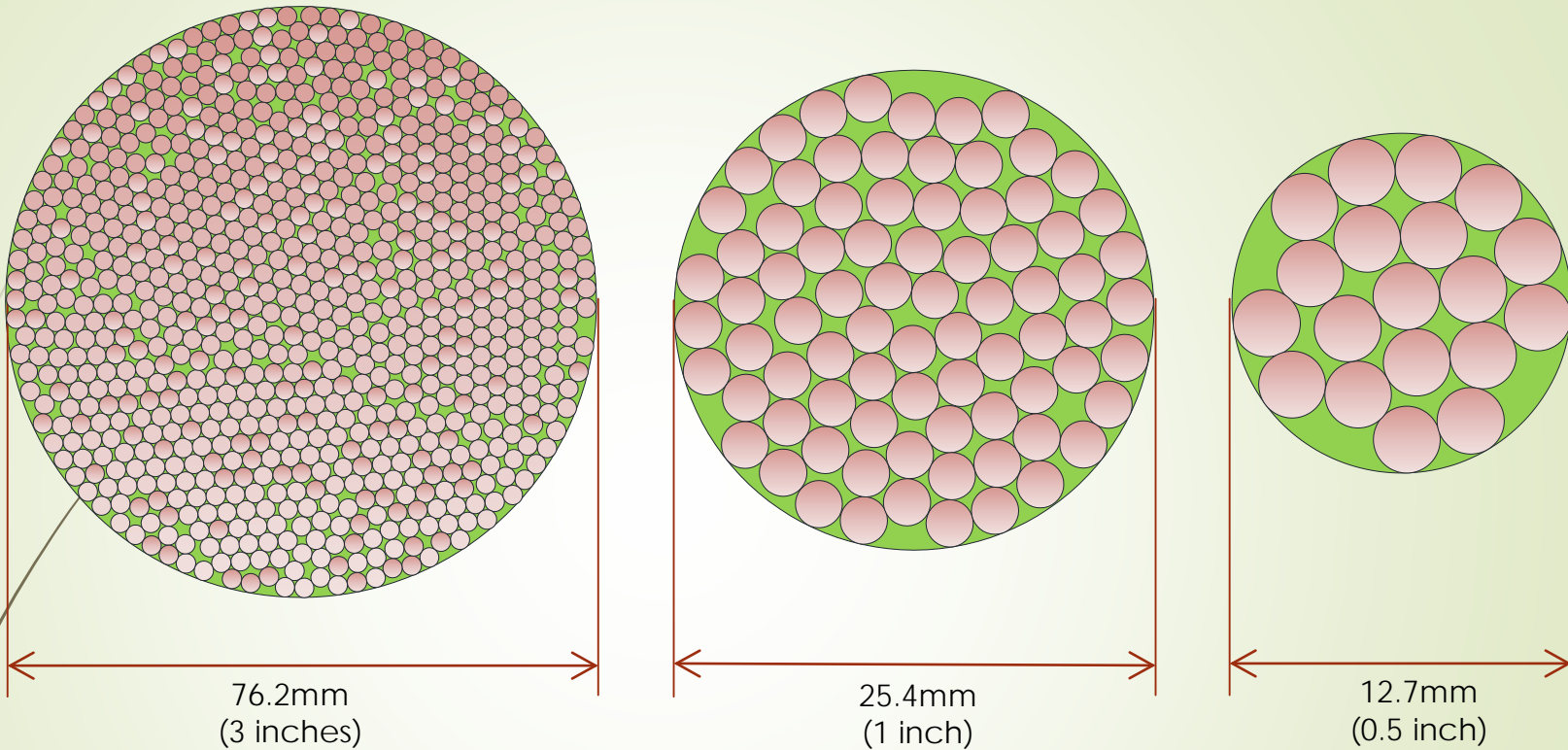

- In a packed bed, as the ratio of pellet diameter to cross section hydraulic diameter increases, a disproportionate flow may bypass the main bed for the high porosity regions near the bounding volume of the bed container.
- Three random pellet packing's to illustrate the channeling effect are shown for 2.5 mm diameter spherical pellets.

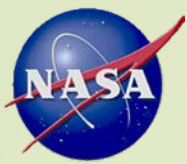

# International Space Station (ISS) Carbon Dioxide Removal Assembly (CDRA)

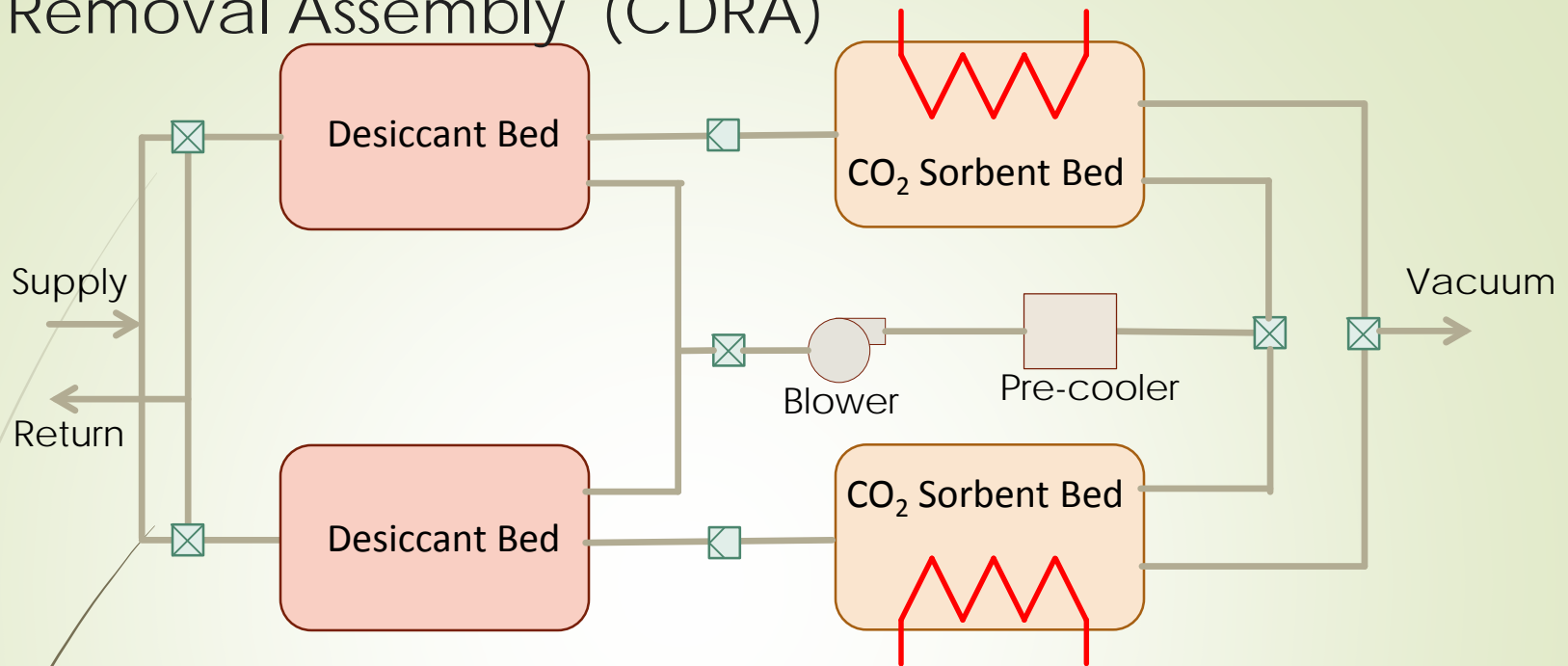

- The CDRA contains two pelletized adsorbent beds to remove CO<sub>2</sub> respired by the crew. Each CO<sub>2</sub> adsorbent bed is paired with an upstream desiccant bed to condition the inlet air (i.e. remove water vapor) prior to entry into the adsorbent bed.
- While one adsorbent bed is actively capturing CO<sub>2</sub> at near ambient pressure, the other is regenerated through applied heat and vacuum desorption.
- The heaters and associated fins form many small axial channels through the length of the adsorbent beds (which are approximately 8 mm x 13 mm in cross section).

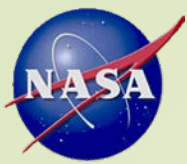

# CDRA Sorbent Bed Cross Section

- The CDRA sorbent bed channels are filled with spherical adsorbent pellets such that each channel span may only contain 4-6 pellets across.
- The small channels facilitate heat transfer from embedded heaters and fins during CO<sub>2</sub> desorption.
- At this small size wall effects may be laterally felt deep into the channel domain and increased bed porosity near the wall may affect axial pressure drop, lateral heat transfer and adsorbent performance.
- The beds are filled with spherical Zeolite 5A pellets (UOP RK-38) that are nominally 2.1 mm in diameter.

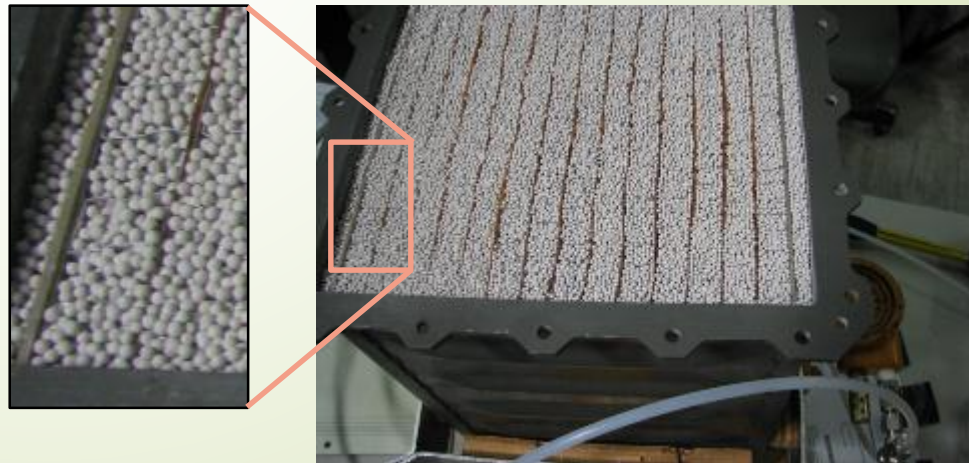

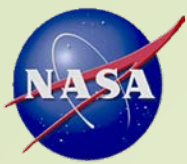

# Spherical Packing Algorithm(BUMPS)

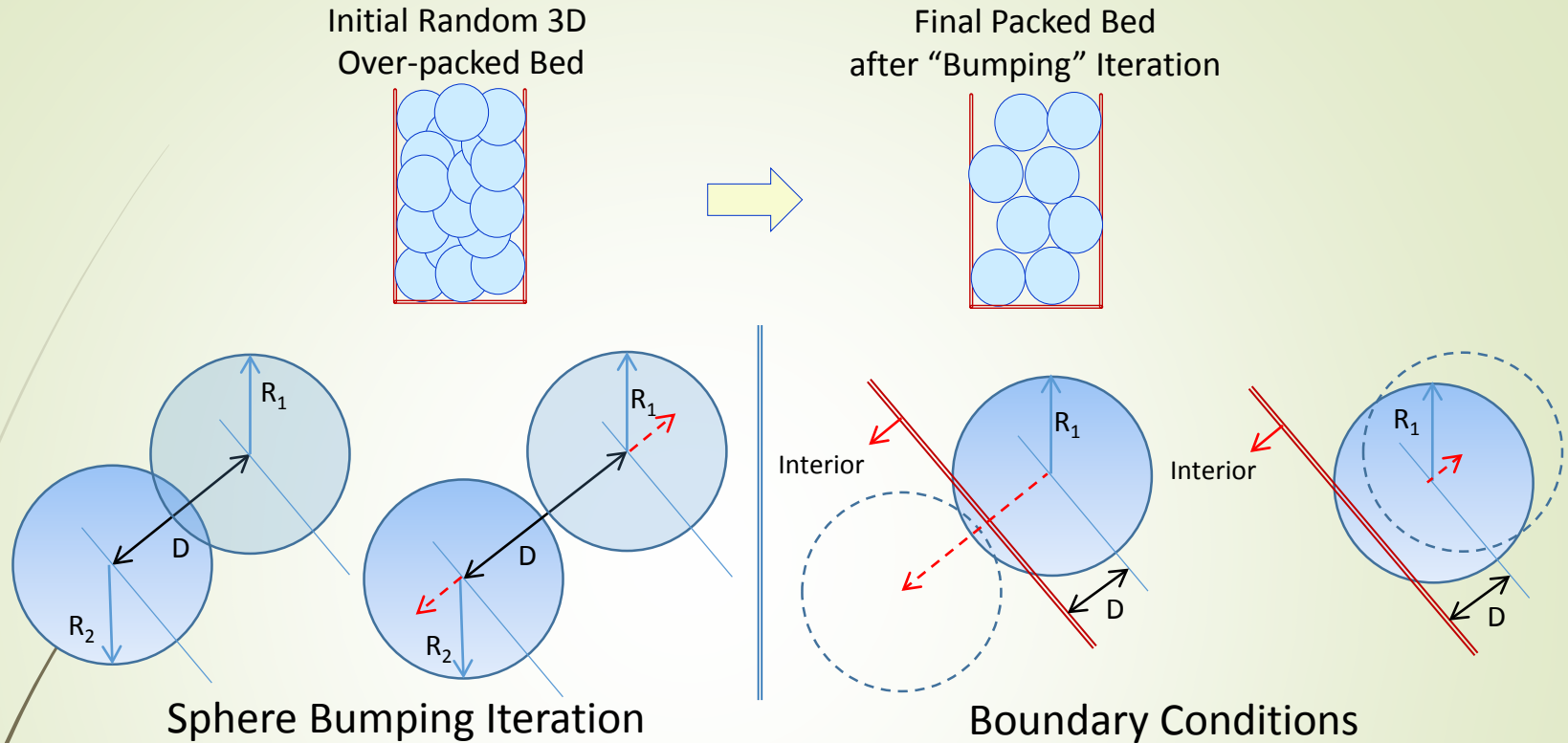

- A simplified sphere packing algorithm has been developed to randomly place identical sized (or sampled from a distribution) spheres inside of a truncated CDRA sorbent bed channel.
- The algorithm is initialized with a random over filled channel of spherical pellets (i.e. overlapping spheres) and, through an iterative "bumping" process, excess spheres are removed.

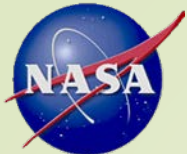

# Large-scale Atomic/Molecular Massively Parallel Simulator (LAMMPS)

- LAMMPS is a classical molecular dynamics code that models an ensemble of particles in a liquid, solid, or gaseous state. It can model atomic, polymeric, biological, metallic, granular, and coarse-grained systems using a variety of force fields and boundary conditions.
- The granular discrete element method capabilities of LAMMPS are built upon in an open source code called LIGGGHTS (LAMMPS improved for General Granular and Granular Heat Transfer Simulations). LIGGGHTS is part of a software suite developed by DCS Computing which also includes CFD software and coupled CFD-DEM software.

LAMMPS is developed and maintained by Sandia National Laboratories: <http://lammps.sandia.gov/>  
LIGGGHTS is developed, distributed and maintained by DCS Computing: <http://www.cfdem.com/>



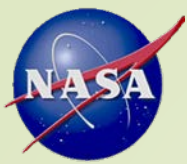

# Spherical Packing

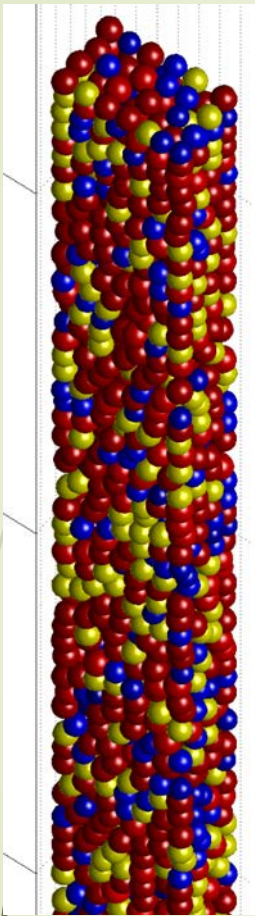

Isometric View

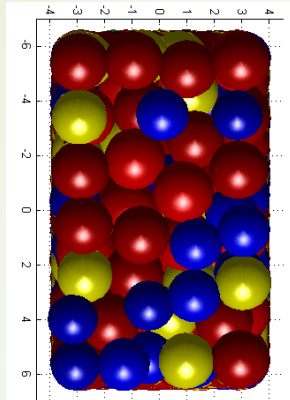

Top View

- Developed polydisperse packed bed model of CDRA channel over entire length using LAMMPS.
- Particle size distribution obtained from photographic analysis.
- Observed effective solid fraction in the channel of 56%.
- Developed COMSOL Java application to import truncated channel via neutral file.

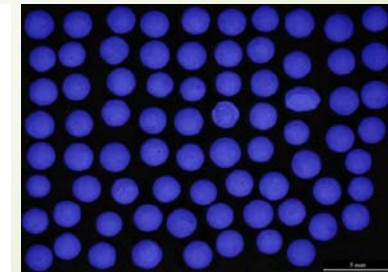
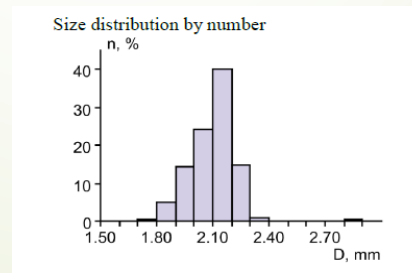

Particle Distribution and Optical Image Analysis

LAMMPS Packing of Individual CDRA Channel



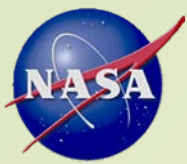

# COMSOL CDRA Channel Model

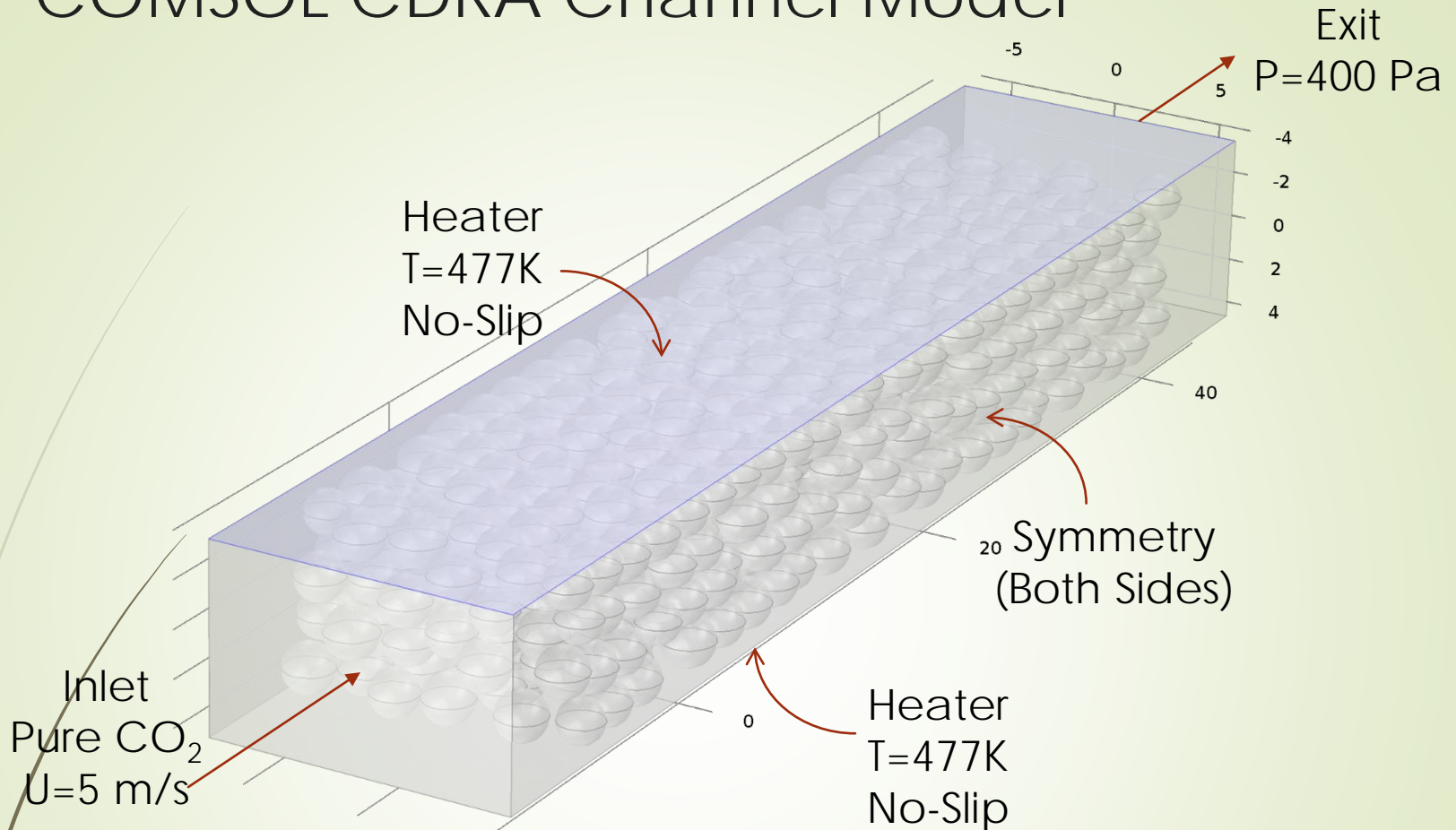

- Developed application utilizing COMSOL Java API to import truncated channel geometry via neutral file.
  - Utilized Boolean operations within COMSOL to create flow-field and solid pellet geometries
  - Also used API for placement of strategic points at pellet centers.
- The mesh contains 1.6 million elements with representative boundary conditions as described.

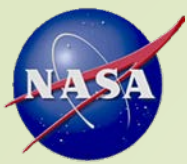

# CDRA Channel Stationary Results

Surface: Temperature (K)

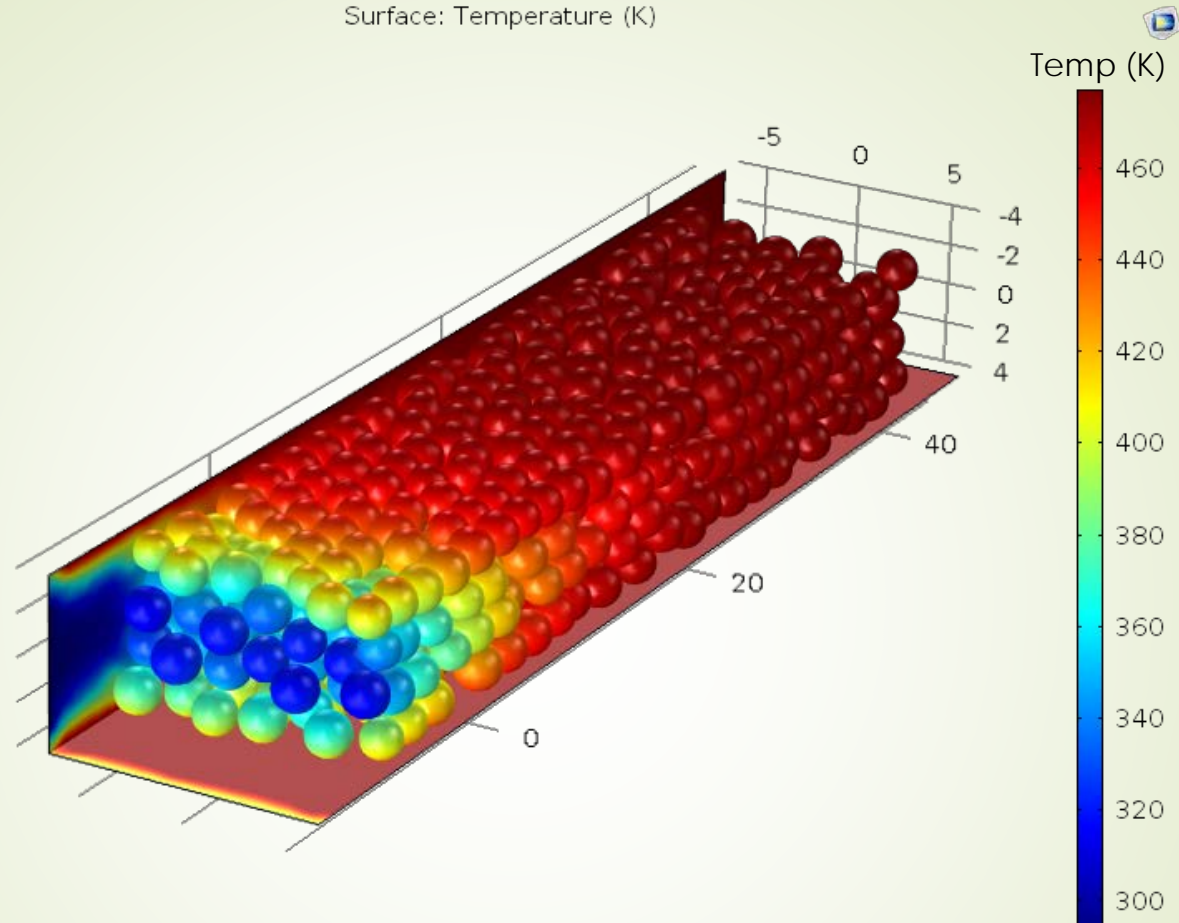

- Surface temperature profiles are shown for a cold flow entering the sorbent channel with the heaters surfaces at prescribed set-points.
- The thermal entrance length is short as the stationary results show a slow moving fluid significantly warming the pellets in less than half the length of the truncated channel.

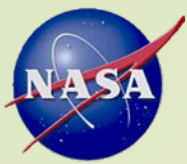

# Convective Heat Transfer Coefficient Estimate

- Estimated the convective heat transfer coefficient from COMSOL prediction using fit of ideal energy balance on individual pellet.
- Chose downstream pellet from outside entrance region.

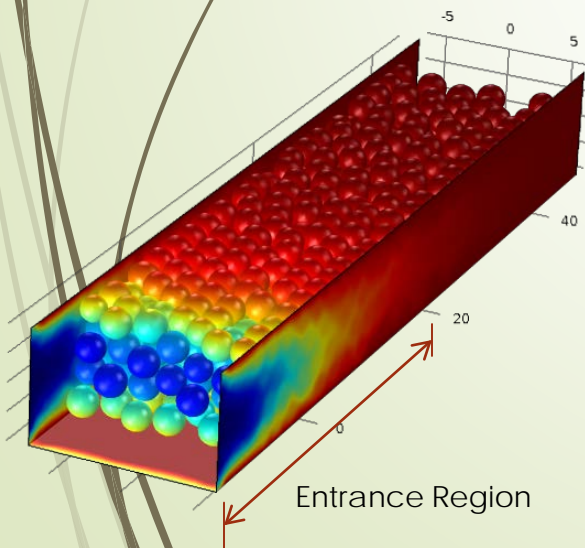

### Individual Pellet Thermal Response

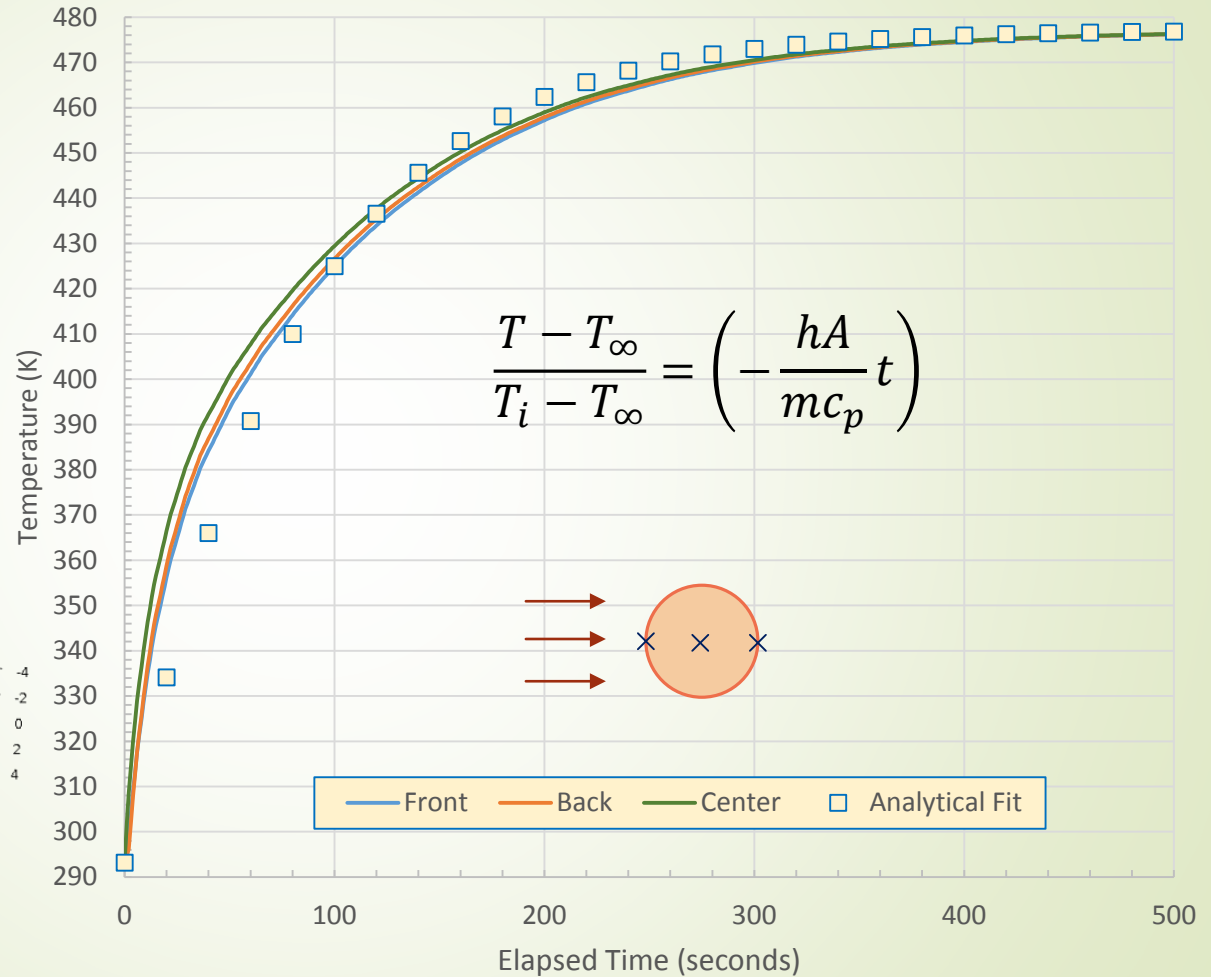

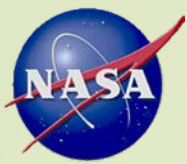

# Channel Effective Thermal Conductivity

- Parametric estimation of packed bed effective thermal conductivity.
- Wall/edge effects eliminated.

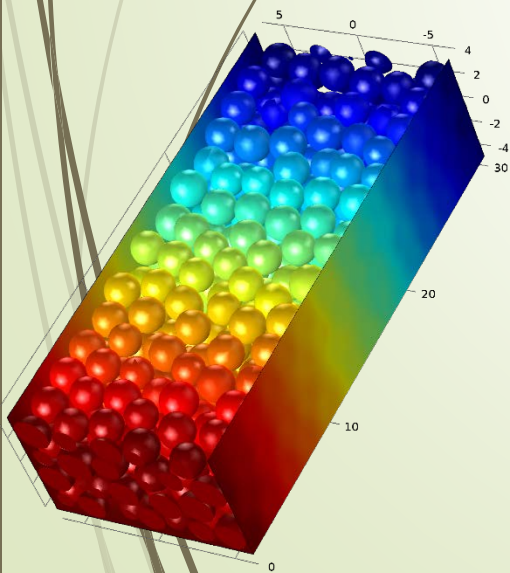

Effective Packed Bed Thermal Conductivity

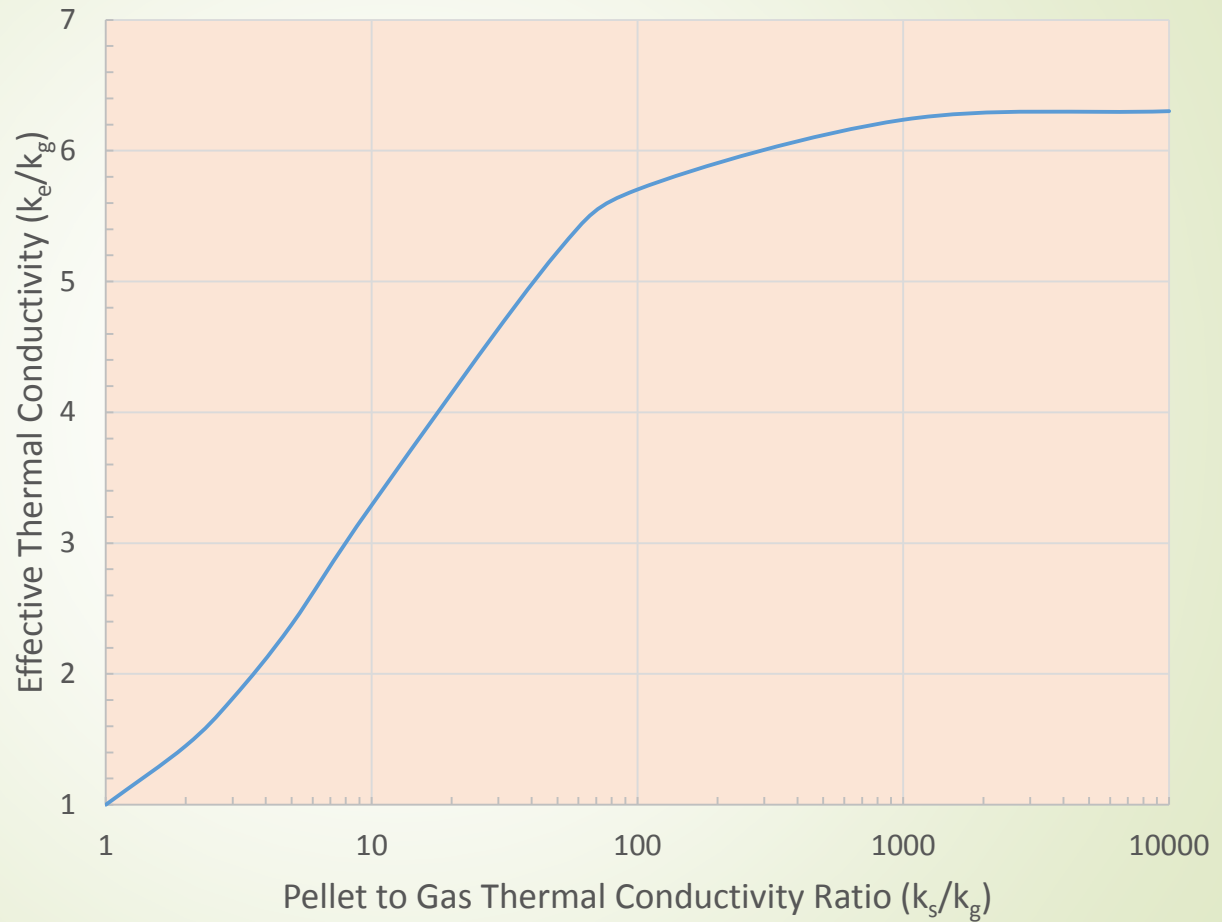

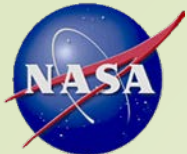

# Conclusions/Future Plans

- This effort successfully demonstrated integration of randomly generated spherical packed bed geometries into COMSOL for investigation of channeling effects on heat transfer and pressure drop.
- Much work to be done; future plans include:
  - Investigation of pellet spacing (i.e. overlap to simulate contact) sensitivity on heat transfer coefficient and pressure drop.
  - Investigation of channel heat transfer effects due to re-radiation between high emittance pellets.
  - Comparison of pressure drop predictions to other empirical formulations (than Ergun).
  - Inclusion of  $\text{CO}_2/\text{H}_2\text{O}$  adsorption physics in the flow simulation.