



# Analysis of Electromagnetic Propagation for Evaluating the Dimensions of a Large Lossy Medium

A. Pellegrini, F. Costa



14-16 October 2009

# Outline

---

- ✓ Introduction to the propagation problem;
- ✓ Formulation;
- ✓ Comsol Multiphysics model and geometry;
- ✓ Results;
- ✓ Conclusions

# Introduction

In Geophysics prospection, the dimensions of the layered structures are very important to be determined

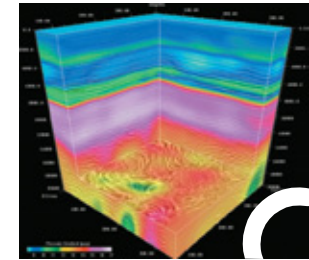

## Approach to evaluate the dimensions of a large structure:

- ✓ the bounded object is illuminated by using an electromagnetic plane wave;
- ✓ the time that the signal takes to be received is observed;
- ✓ the delay, needed to complete a round trip, provides information about the distance that the plane wave covers in the lossy medium;

## Two effects have to be taken into account:

- ✓ the attenuation of the electromagnetic signal, depending on the losses of the material;
- ✓ the reflection of the electromagnetic signal by the discontinuities;

Consequently an electromagnetic signal can be detected not only if a reflection appears, but also if the signal is not strongly attenuated

# Physics of propagation: the attenuation

Let us assume that the incident electric field is polarized in the z direction and propagates along x axes

The losses in the media introduce an exponential attenuation of the electric field

$$E_i = E_0 e^{-jkx} \hat{z}$$

The complex wavenumber is expressed as:

$$k_r = \omega \sqrt{\frac{\mu_n \epsilon_n}{2}} \left[ \sqrt{1 + \left( \frac{\sigma_n}{\omega \epsilon_n} \right)^2} + 1 \right]^{1/2} ;$$

$$k_i = \omega \sqrt{\frac{\mu_n \epsilon_n}{2}} \left[ \sqrt{1 + \left( \frac{\sigma_n}{\omega \epsilon_n} \right)^2} - 1 \right]^{1/2}$$

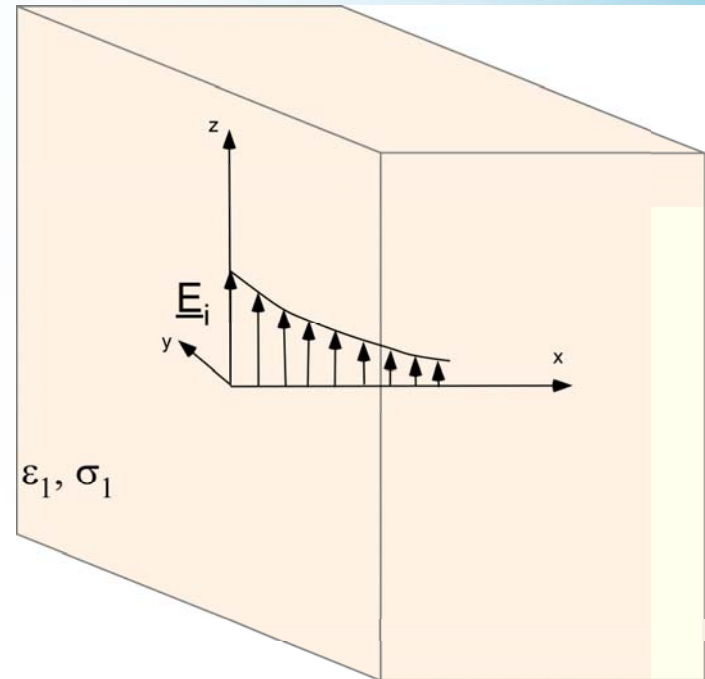

Where  $k_r$  and  $k_i$  are the phase and attenuation constants, respectively

# Physics of propagation: the reflection

When a plane wave impinges on a planar surface, the reflected and transmitted electric field depend on the incident one by means of the reflection and transmission coefficient evaluated on the discontinuity

The reflection and transmission coefficient are strictly dependent on the difference of the electromagnetic properties between the two media

$$\begin{aligned}
 E_i &= E_0 e^{-jkx} \hat{z}; \\
 E_r &= E_0 \Gamma e^{jkx} \hat{z}; \\
 E_t &= E_0 \tau e^{-jkx} \hat{z}.
 \end{aligned}
 \quad
 \begin{aligned}
 \Gamma &= \frac{\eta_2 - \eta_1}{\eta_2 + \eta_1}; \\
 \tau &= \frac{2\eta_2}{\eta_1 + \eta_2}.
 \end{aligned}$$

Where the intrinsic impedance of the medium is:

$$\eta = \sqrt{\frac{j\omega\mu}{\sigma + j\omega\varepsilon}}$$

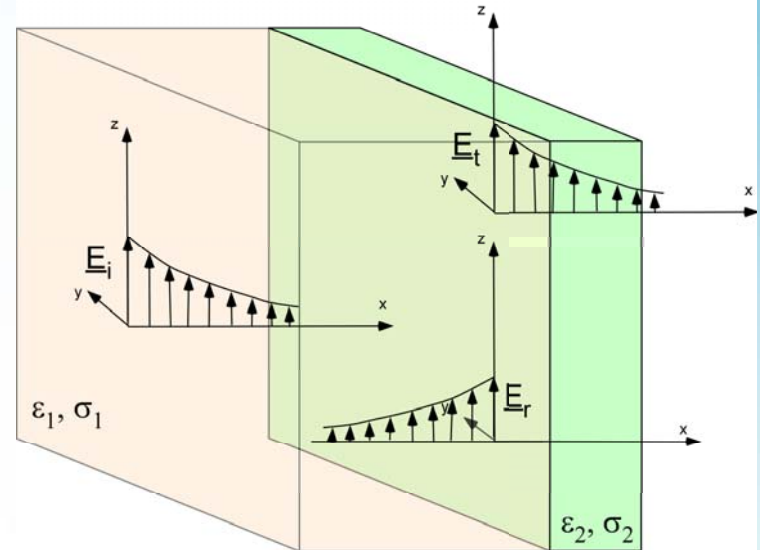

Total reflection and the critical angle: propagation from a more dense medium to a less dense medium

$$\varepsilon_2 < \varepsilon_1$$

$$\theta_i \geq \theta_c = \sin^{-1}(\sqrt{\varepsilon_2 / \varepsilon_1})$$

# Time dependent analysis

In the transient analysis the electric field source has been synthesized as the first derivative of the Blackman-Harris pulse function with centre frequency 100 MHz

$$E_z = -0.7 \sin(5.5e8t) + 0.4 \sin(11.0e8t) - 0.045 \sin(16.5e8t)$$

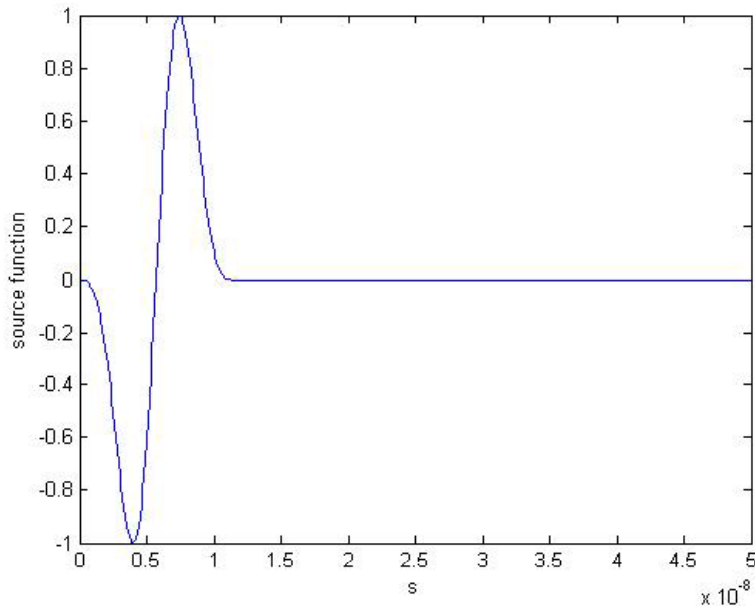

The reflected and attenuated electromagnetic signal is received with a delay  $T$ , therefore the length  $L$  of the wedge is calculated as

$$L = \frac{c}{\sqrt{\epsilon_r \mu_r}} T$$

# The Geometry

The investigated geometry is a large composite structure consisting in a lossy dielectric box which contains a wedge-shaped lossy dielectric medium.

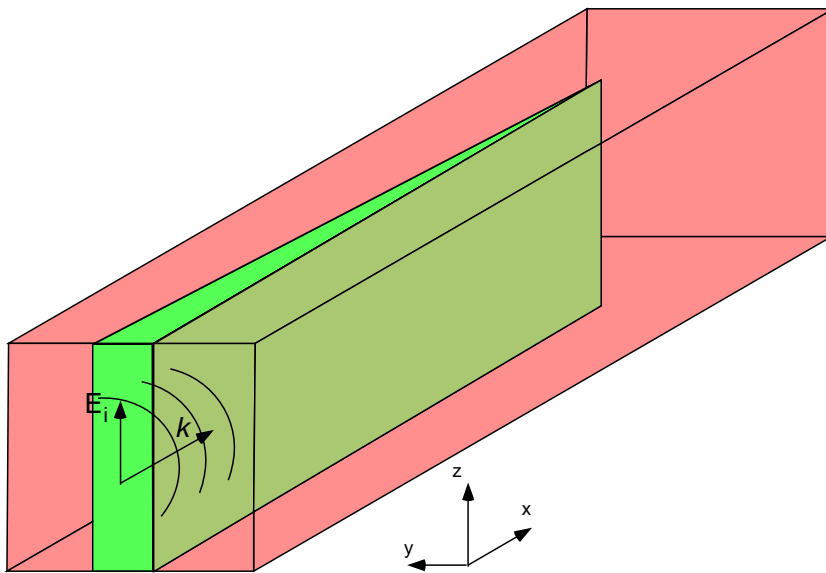

- ✓ A plane wave that illuminates the left side (yz plane) of the structure;
- ✓ The electromagnetic field  $E_i$  propagates along +x direction undergoing an attenuation depending on the medium losses;
- ✓ The electric field is reflected by the wall discontinuity (wedge-box) towards the source (receiver) undergoing a further attenuation.

By measuring the delay of the reflected and attenuated electromagnetic field, it is possible to obtain the covered path that represents the length of the structure.

# Reduced Numerical Model

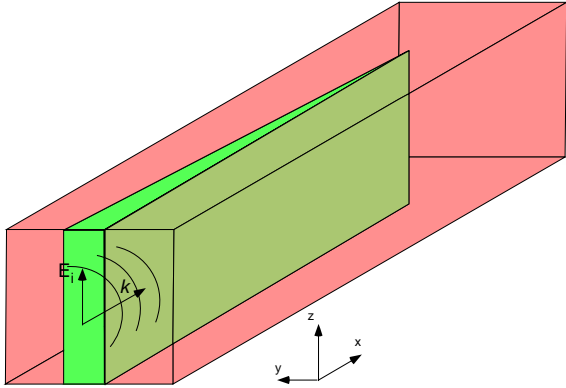

Electric Field evaluated in the wedge in 3D problem

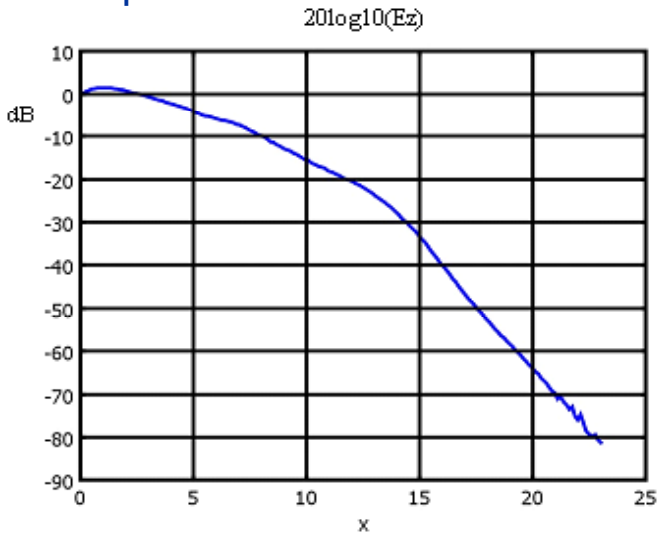

Electric Field evaluated in the wedge in 2D problem

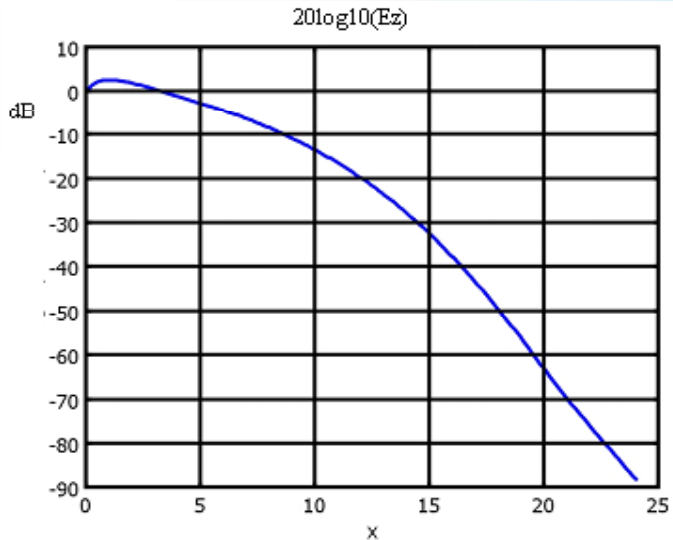

No guiding effects appear therefore the 3D problem is reduced to the equivalent 2D one by considering a section parallel to xy plane



The computational domain consists of a structure of 21 m by 4 m surrounding a dielectric wedge of 20 m length by 0.5 m wide

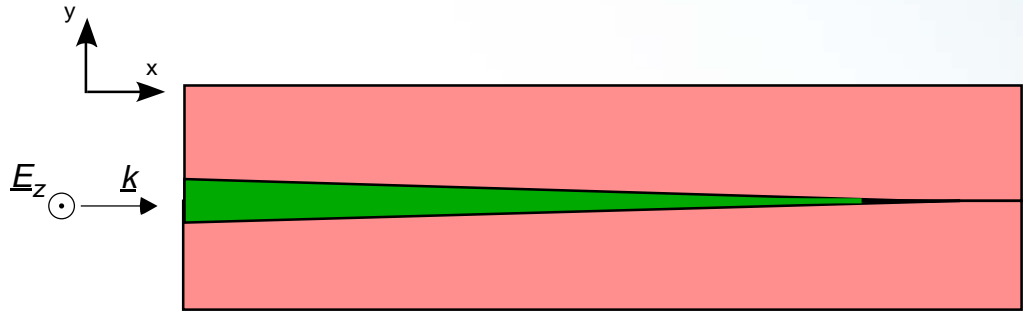

The mesh has been obtained by imposing the maximum length of the triangle of  $\lambda/10$

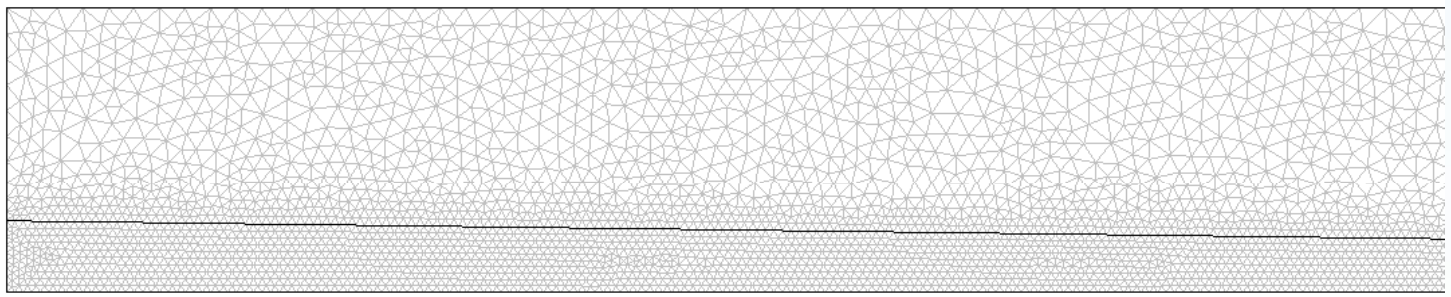

# Boundary Conditions

By considering the symmetry of the problem respect to the x axis, the study is reduced to half structure

- ✓ A plane wave have been used to synthesize the excitation;
- ✓ Scattering boundary conditions have been used avoiding spurious reflections;
- ✓ PMC conditions have been used to assure the continuity of the electric field;

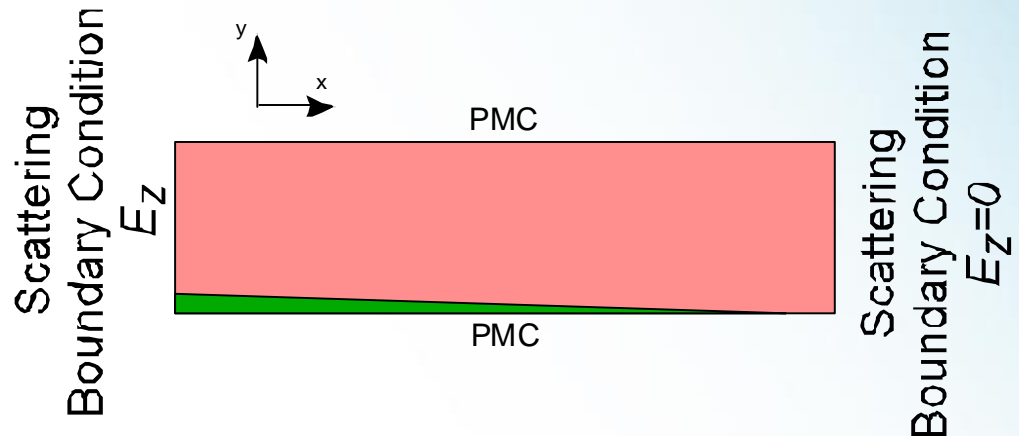
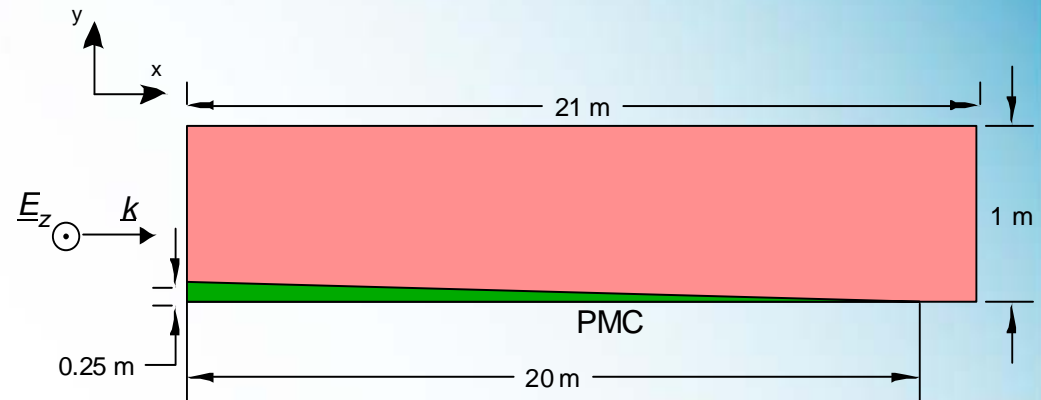

No PML have been used in order to avoid the increasing of the computational domain

# Numerical Results

## Frequency dependent analysis: 100MHz

Dielectric rectangular box:

- $\epsilon = 5 - 0.359j$ ;
- $21m \times 1m$ ;

Dielectric wedge:

- $\epsilon = 10 - 0.071j$ ;
- $20m \times 0.25m$ ;

The signal outside the wedge involves in a greater attenuation respect to the one in the wedge

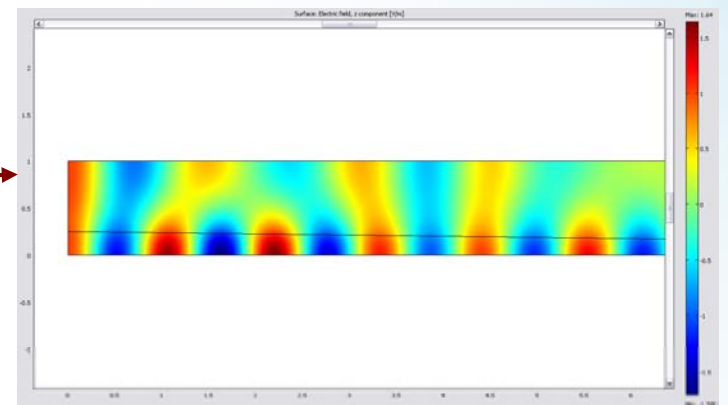
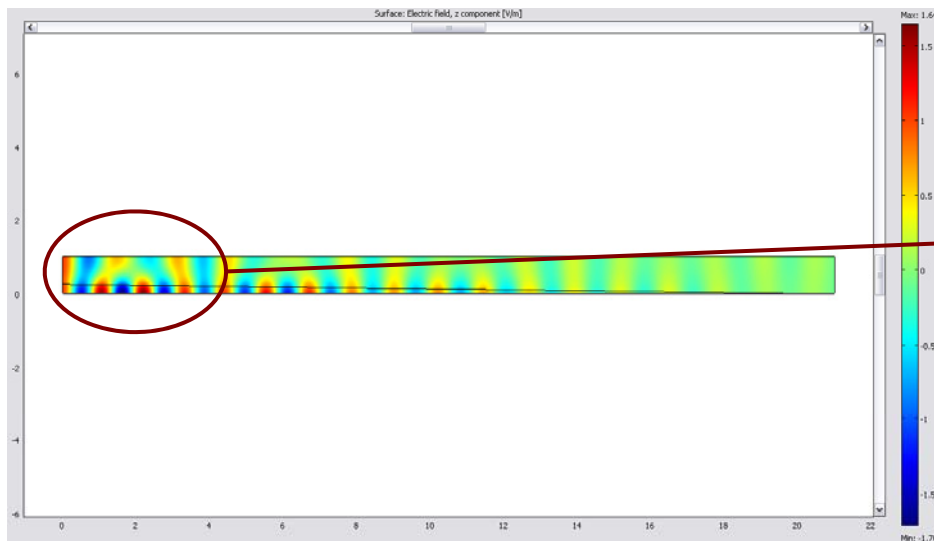
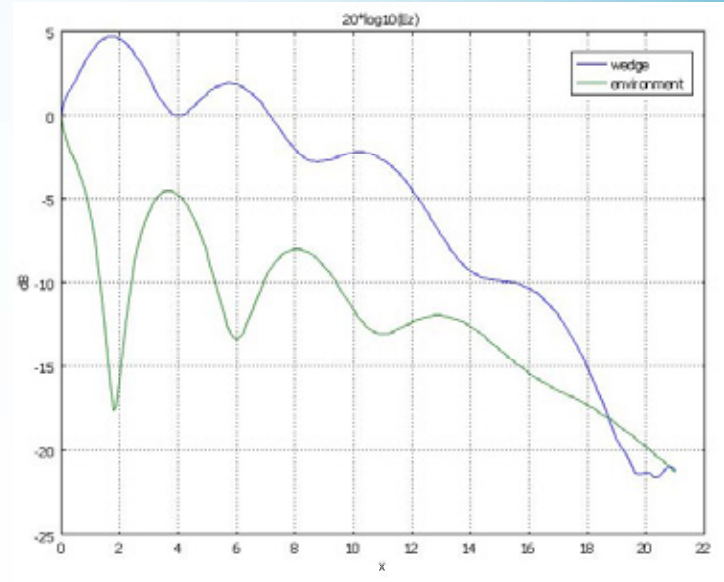

# Numerical Results

Dielectric rectangular box:

- $\epsilon = 5-0.359j$ ;
- $21m \times 1m$ ;

Dielectric wedge:

- $\epsilon = 10-0.071j$ ;
- $20m \times 0.25m$ ;

$$L = \frac{c}{\sqrt{\epsilon_r \mu_r}} T$$

Expected Echo:

$$t = 410^{-7}s$$

Time dependent analysis

After  $t = 63 \text{ ns}$  the signal propagates for  $6m$

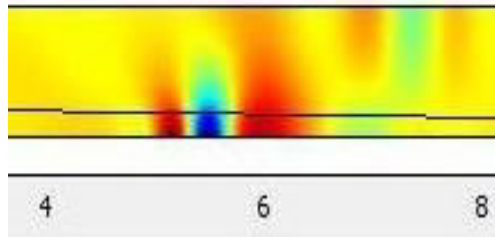

After  $t = 140 \text{ ns}$  the signal propagates for  $13.2m$

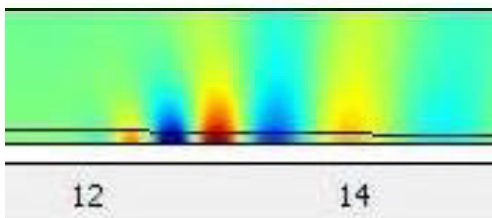

After  $t = 390 \text{ ns}$  the signal propagates for  $37m$

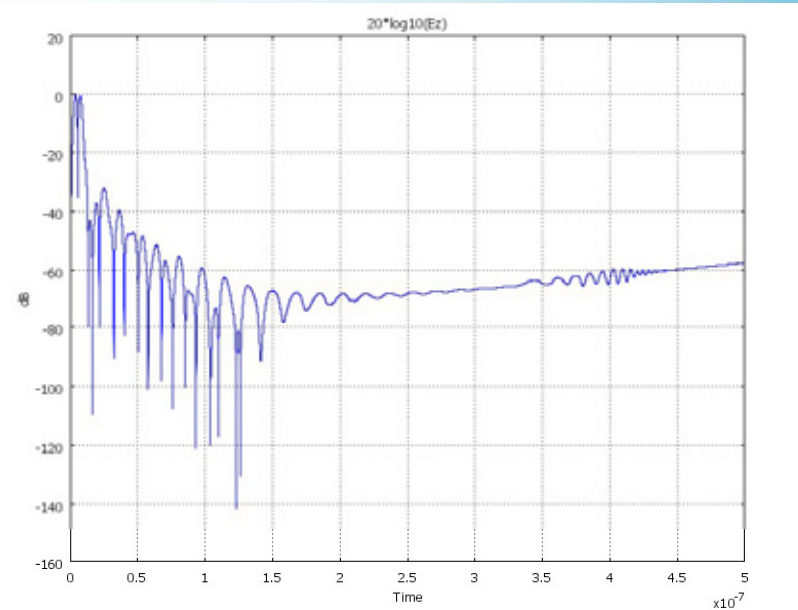
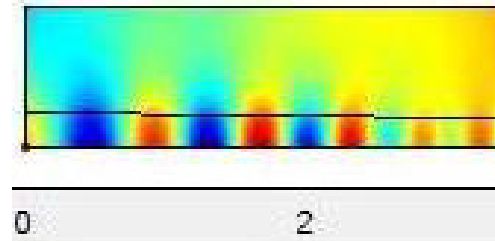

# Numerical Results

Dielectric rectangular box:

- $\epsilon_r = 10 - 0.359j$ ;
- $16m \times 1m$ ;

Dielectric wedge:

- $\epsilon_r = 5 - 0.071j$ ;
- $15m \times 0.25m$ ;

$$L = \frac{c}{\sqrt{\epsilon_r \mu_r}} T$$

Expected Echo:  
 $t = 2.2 \cdot 10^{-7} s$

## Time dependent analysis

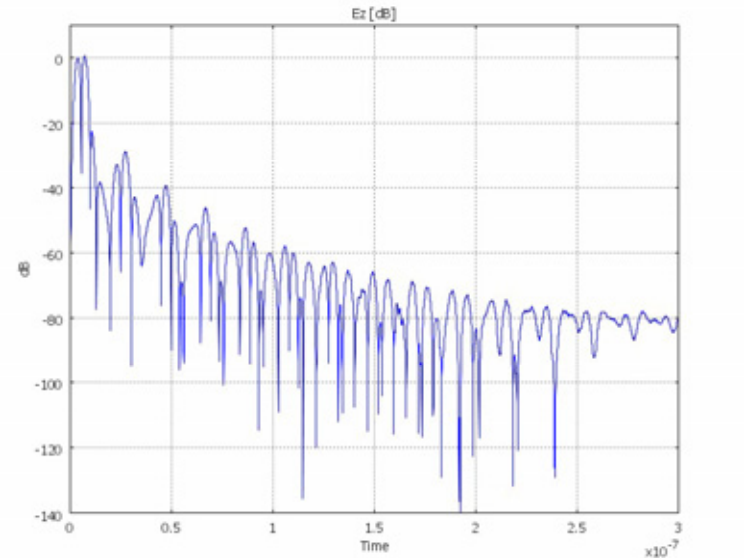

Frequency dependent analysis: 100MHz

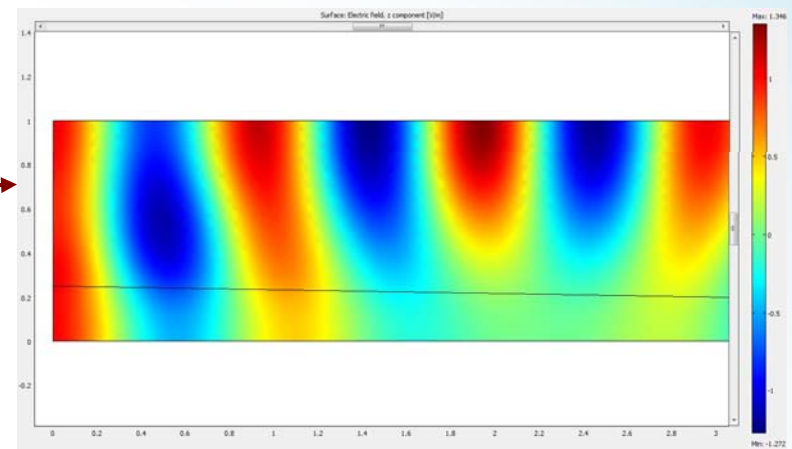
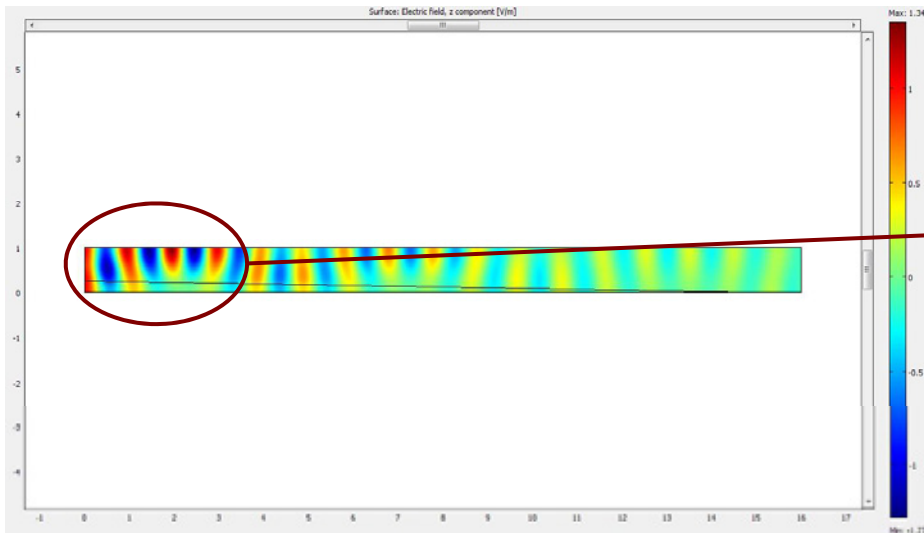

- ✓ The physics of propagation has been illustrated;
- ✓ The investigated geometry and the numerical model with properly boundary conditions have been presented;
- ✓ The in-frequency and in-time domain analysis have allowed us to well understand the propagation phenomena in a lossy bounded dielectric medium.
- ✓ The detection of the reflected and attenuated electromagnetic signal have permitted us to determine the dimensions of the structure according to the electromagnetic characteristics of the geometry.