

Modelling the Electrical Parameters Of A Loudspeaker Motor System With The AC-DC Module – (MEPLMSAM)

M. Cobianchi^{*1}, Dr. M. Rousseau^{*1} and S. Xavier^{*1}

¹B&W Group Ltd, Worthing, West Sussex, England.

*Corresponding author: mcobianchi@bwgroup.com, mrousseau@bwgroup.com, sxavier@bwgroup.com.

Abstract: The main purpose of a drive unit is to transform the electrical signal at its terminals into acoustic waves via two transduction mechanisms:

- Electro-mechanical, through the voice coil with the static magnetic field in the motor assembly.

- Mechano-acoustical through the membrane and its suspensions.

In this paper only the electro-mechanical transformation is discussed. The focus is on the modelling, in view of a future optimization of the main electrical parameters for a loudspeaker motor: the Force Factor (Bl) and the Blocked Impedance (Zb) as functions of the voice coil position.

Here, the COMSOL model is described and then compared to the implementation of a similar model in the software FEMM (FiniteElementMethodMagnetic).

The experimental validation of the model is presented by comparing the "Force Factor (Bl)" and "Blocked Impedance" versus displacement curves to these quantities measured with a tensile test machine (quasi-static setup) and the Klippel analyzer (dynamic setup).

Keywords: Loudspeaker motor, Force factor, Blocked impedance, Modelling, Tensile test machine.

1. Introduction

The aim of this project is to improve the modelling and measurement process for loudspeaker motor systems. First, several systems were simulated using the Finite Element analysis both in COMSOL 5.1 and FEMM 4.2 to assess the physics implementation and software impact on the main electrical parameters estimation (Bl & electrical impedance) as well as to see which method is best suited for a development work (computation time).

Then, measurements were performed on a tensile test machine and the Klippel Distortion analyzer, in order to verify the accuracy of the

models and also to estimate the impact of the two different setups which are relying on completely different assumptions.

Here only a representative sample of the many motors analyzed is presented and discussed.

First a magneto-static analysis is done both in COMSOL and FEMM. This kind of analysis is one of the first to be done for the development of a new motor: it gives useful information about the electromagnetic transduction and the efficiency of the system (saturation of the ferromagnetic material, working point of the magnet, flux density profile in the air gap, force on the voice coil).

Moreover a frequency analysis is run in COMSOL in order to simulate the blocked coil impedance. This analysis is useful to assess the inductance non-linearity as a function of the voice coil position and frequency. It is the first step in the process of linearizing the inductance behaviour (with demodulation rings for example).

The drive unit considered in this study is a 6.5 inch unit with a simple ferrite motor (Bass-mid frequency unit), show below:

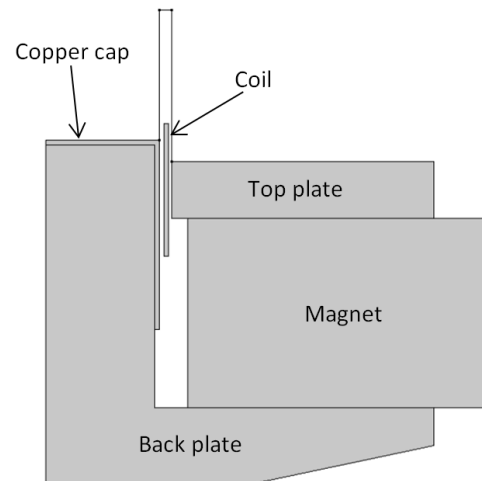

Figure 1. 2D model under study

2. Theory

For an electromagnetic problem, the starting point is the set of Maxwell equations.

$$\left\{ \begin{array}{l} \nabla \times \vec{E} = -\frac{\partial \vec{B}}{\partial t} \quad \text{Gauss law (Faraday law)} \\ \nabla \cdot \vec{B} = 0 \quad \text{Gauss law (magnetic field)} \\ \nabla \cdot \vec{D} = \delta \quad \text{Gauss law (electric field)} \\ \nabla \times \vec{H} = \vec{J} + \frac{\partial \vec{D}}{\partial t} \quad \text{Ampere Maxwell Law} \end{array} \right.$$

And a relation between \vec{B} and \vec{H} can be written:

$$\vec{B} = \mu \vec{H}$$

With:

- \vec{J} - Current density.
- \vec{D} - Electric flux density.
- \vec{E} - Electric field intensity.
- \vec{B} - Magnetic flux density.
- \vec{H} - Magnetic field intensity.
- μ - Permeability.
- δ - Electric charge density.

In the case of this study, the option “Remanent flux density” was used and leads to the following set of constitutive relations:

$$\left\{ \begin{array}{l} \vec{D} = \epsilon_0 \vec{E} + \vec{P} \\ \vec{B} = \mu_0 \mu_r \vec{H} + B_r \\ \vec{J} = \sigma(\vec{E} + \vec{v} \times \vec{B}) + J_e \end{array} \right.$$

With:

- ϵ_0 - The vacuum permittivity.
- \vec{P} - Electric polarization vector (it describes the behaviour of the material under a field \vec{E}).
- μ_0 - Permeability of air and μ_r the relative permeability of the material.
- B_r - The remanence of the magnet.
- v - Velocity of the conductor (in the magnetic field).
- J_e - External current density

For a quasi-magneto-static analysis, all the time derivative terms ($\partial/\partial t$) and all the terms related to the electric field (\vec{E}) are neglected.

This leads to:

$$\left\{ \begin{array}{l} \nabla \cdot \vec{B} = 0 \\ \nabla \cdot \vec{D} = 0 \\ \nabla \times \vec{H} = \vec{J} = \sigma(\vec{v} \times \vec{B}) + J_e \end{array} \right.$$

For the present study, all the problems are simplified due to the symmetry of the device (2D - axisymmetric). So here the \vec{B} field is solenoidal and a vector potential \vec{A} can be introduced which follows the relation:

$$\vec{B} = \nabla \times \vec{A}$$

Combining the previous equations, the formulation implemented in COMSOL is easily found:

$$\nabla \times (\mu_0^{-1} \mu_r^{-1} (\vec{B} - B_r)) - \sigma \vec{v} \times \vec{B} = J_e$$

3. Magneto-static analysis

First a magneto-static analysis was done on COMSOL and FEMM in order to model the force factor.

3.1 Model implementation on COMSOL

The model is a 2D axisymmetric problem where all the geometrical dimensions are parametrized in view of a future optimization.

The AC/DC module - Magnetic Field (mf) is used with a stationary study (for the force factor). In order to be able to compare the results with FiniteElementMethodMagnetics package which is using first order triangular elements for the discretization, a linear discretization was used to perform the computation in COMSOL as well.

The computation domain was set as half of a circle representing the air domain. The radius was set at twice the biggest linear dimension of the system according to [1], where a magnetic insulation boundary condition was used to close the domain.

- **Physics**

The physics used was the following:

- For the soft iron parts an ampere's law was set using the constitutive relation HB curve. The HB curve values used were measured with an hysteresis-graph.
- For the magnet, a constant field Br was set using the constitutive relation Remanent flux density (the Br value of the magnet was set in the z-direction according to the magnetization direction), and the permeability set to a constant value linearizing the BH curve (again measured with an hysteresis-graph). This is valid as long as the working point of the magnet is far from the knee of the BH curve.
- For the air domain, the copper sleeve and the coil, an ampere's law specifying a constant unitary relative permeability was set.

- **Meshing**

To mesh such a geometry, the main issue is to set the maximum element size taking into account the region of interest (finer mesh in the air gap) and to try to keep the number of elements relatively low in order to reduce the computation time. According to [1] and [2], the mesh size for second order triangular elements should be:

	Maximum element size (mm)
Air gap	0.2
Motor and magnet	2
Air domain	15

Table 1. Mesh – second order triangular element size

This means that for first order triangular elements the maximum element size should be approximately:

	Maximum element size (mm)
Air gap	0.1
Motor and magnet	1
Air domain	7.5

Table 2. Mesh – first order triangular element size

- **Computation**

A parametric sweep was implemented in order to move the coil up and down and then calculate all the physical values linked to its displacement.

To model the force applied to the voice coil with unitary current flow, an average coupling variable was used on its domain (*aveop_coil*) and the value of the force factor is computed with this formula:

$$Bl = 2\pi * TURN * aveop_coil(mf.Br * r)$$

With TURN being the number of turns of the winding and mf.Br the radial component of the flux density.

3.2 Model implementation on FEMM

The model implementation won't be fully described here but the key settings were:

- The geometry was imported via a DXF file from COMSOL, so the same geometry is used.
- Every domain has a mesh size specified according to the one used in COMSOL.
- The iron parts are using the same nonlinear HB curve used in COMSOL, described as an interpolation function based on a table.
- The magnet is using the same linearized B-H formulation used in COMSOL.
- FEMM can handle a non-linear formulation for the magnet using the full BH curve of the material [4]. This is relevant whenever the material used is inherently highly non linear (like AlNiCo alloys) or shows non linear behaviour with increasing temperature (Neodymium) or decreasing temperature (Ferrite). COMSOL has not implemented such a formulation yet so the comparison could not be done for this paper.

3.3 Tensile test measurement

Originally used for material properties testing (tensile strength, maximum elongation, reduction area etc.) this machine is computer controlled and very versatile.

The coil is attached to the arm and fed with a DC current of 1A while the machine moves the coil in and out of the air gap at 5mm/s and measures the force exerted on the force sensor, the setup is presented in figure 2- 4. The benefit of this technique is that here, contrary to the Klippel system, the force is measured directly and the results obtained are not fitted to a model of the entire transducer. Plus, the force factor measured is purely static, with no eddy currents impact on the results, thus matching exactly the assumptions of a magnetostatic model.

- **Setup**

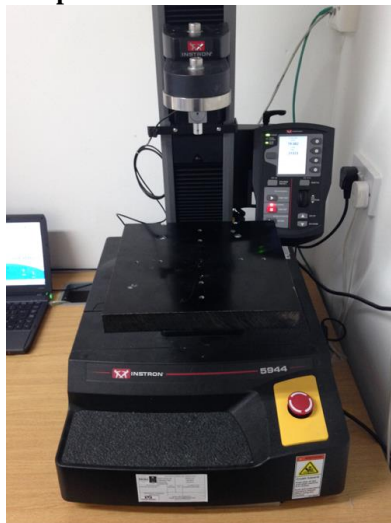

Figure 2. Tensile Test Machine

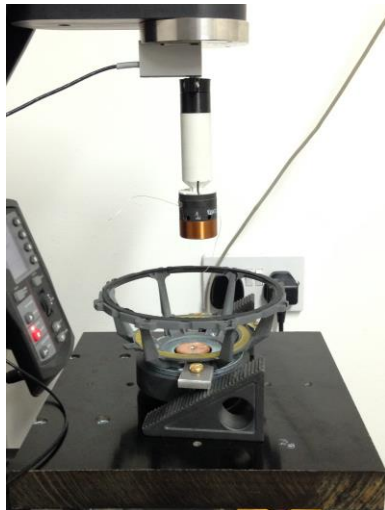

Figure 3. The drive unit motor and the coil ready for a measurement

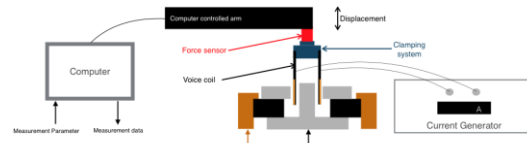

Figure 4 Test Setup

3.4 Results

- **Computational efficiency**

As mentioned in the section 3.1, the mesh has been implemented in order to have roughly the same number of elements in Comsol and FEMM as shown in table 3.

	Number of elements
COMSOL	18090
FEMM	18150

Table 3. Comparison of the number of elements

The two models have been compared for computation times in table 4.

	Computation time (model)
COMSOL	1 minute 04 seconds
FEMM	1 minutes 20 seconds

Table 4. Computation time

COMSOL resulted as the fastest by 16 seconds, which means it takes 80% of the computation time used by FEMM. Although the difference on a single computation is small, on several models analyzed in an optimization problem, it's still a good advantage.

- **Flux density and force factor comparison**

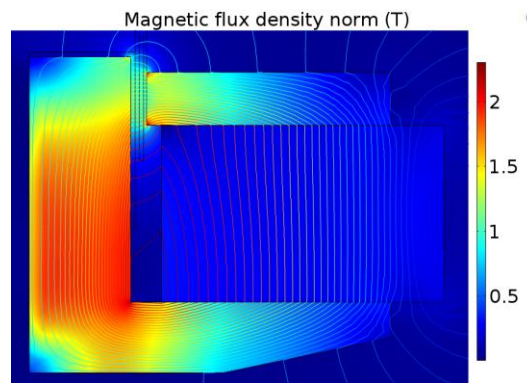

Figure 5. Model - Flux density

The average flux density in the magnet (mf.Bz) is 0.25 T.

The flux density in the air gap (along the coil length) is presented in figure 6.

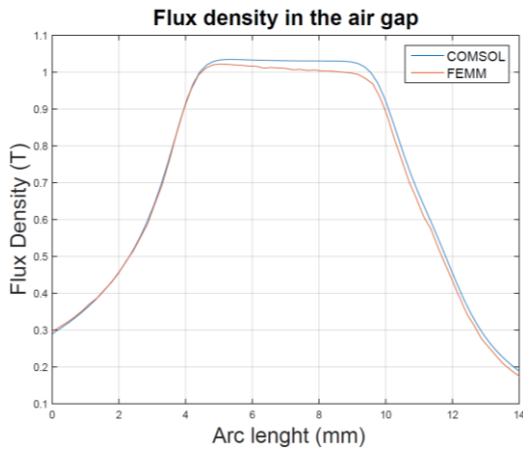

Figure 6. Flux Density in the gap – Comparison COMSOL/FEMM

The results given by the two software packages are very similar. A small difference is noticeable on the plateau of the curve, which represents the variation of the magnetic flux along the top plate thickness.

The force factor modelled (COMSOL and FEMM) and measured on two different motors is presented in figure 7.

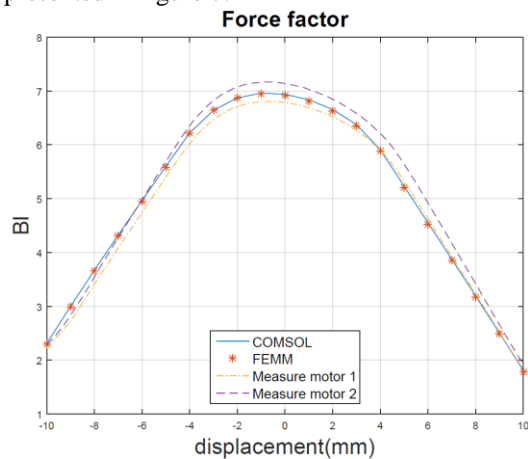

Figure 7. Force factor - Comparison model/measurement.

The two models give very similar results with a difference between them of less than 1%.

The models have an error of respectively 2% and 3% compared to the measured values of motor 1 and 2 which have been chosen as representative

of the maximum spread still within tolerance within our production.

	Error (%)
Measurement motor 1 / model	2.00%
Measurement motor 2 / model	3.00%

Table 5. Force factor - Relative error to the measurement

• **Force factor comparison between static and dynamic setup**

The results of the model (figure 7) and the static setup (figure 8) are compared in this section with the result given by the LSI module [5] of the Klippel DA.

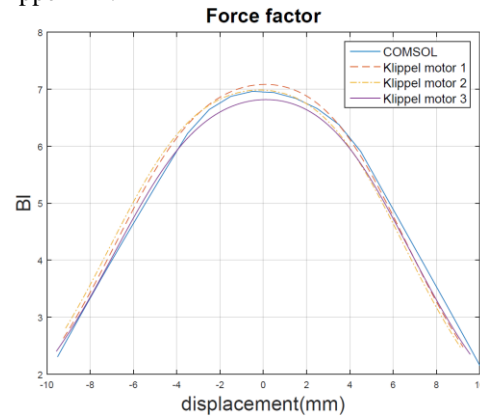

Figure 8. Force factor – comparison model/dynamic setup.

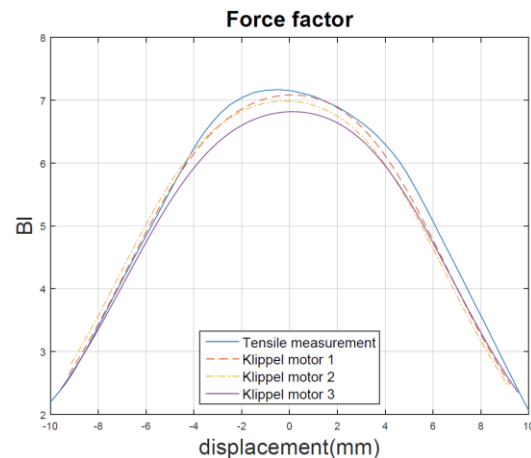

Figure 9. Force factor – comparison max. static / dynamic setup.

In this case the dynamic BI is very close to the static one, and the fitting is very good, but it's worth mentioning that some more elaborate motor configurations tested during this study resulted in a BI curve which couldn't be represented accurately by an 8th order polynomial, and thus the fitted BI curve

measured with the Klippel LSI module [5] showed some artefacts which were not visible in the tensile test measurement.

4. Frequency domain analysis

A frequency domain analysis was done on COMSOL in order to model the blocked impedance. These results were then compared to measurements done with the tensile test machine and custom acquisition software.

4.1 Model implementation on COMSOL

For the modelling of the blocked impedance the same geometry of the magnetostatic case was used but all the metallic plating/coatings were included in the model (in this case zinc on the iron part). This is due to the high electrical conductivity of the material and thus its potential effect on eddy currents distribution. Then a simplified model without the plating was compared to assess the impact of it and find the best compromise in terms of DOF.

- **Physics**

The physics used was as per the magnetostatic case, with the following modifications:

- For the soft iron parts the electrical conductivity was measured as well and specified for the material.
- The voice coil is represented with the feature “multi-turn coil” excited by a voltage via the harmonic perturbation option.
- The electrical conductivity used for the copper sleeve and the zinc plating was the built-in material library value for copper and zinc respectively.

- **Meshing**

The same mesh of the magnetostatic case was used with respect to the maximum element size but due to the presence of eddy currents (induced by the motion of the coil in the magnetic field of the assembly) a boundary layer mesh with at least 3 elements per thickness was added to the iron parts close to the zinc plating. One element per thickness in the zinc layer has proven to be enough.

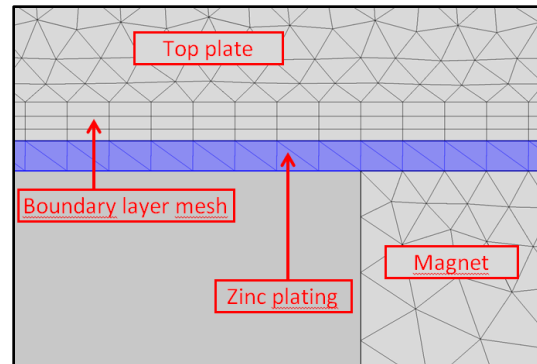

Figure 10. Meshing – Boundary layer mesh.

- **Computation**

As previously, a parametric sweep was implemented in order to move the coil up and down. The impedance was then computed using the input voltage (set in the multi-turn formulation) and the current in the coil directly estimated by COMSOL.

The impedance was computed as following:

$$Z = abs\left(\frac{V0}{lindev(mf.ICoil_1)}\right)$$

- **Solver configuration**

The frequency domain study was solved within the range 20-10000Hz which is approximately one octave below and above the relevant working range of the drive unit (40-5000Hz).

Here the frequency study solver needs to be configured in order that the computation is done taking into account the results of the magnetostatic study, using a linear perturbation approach.

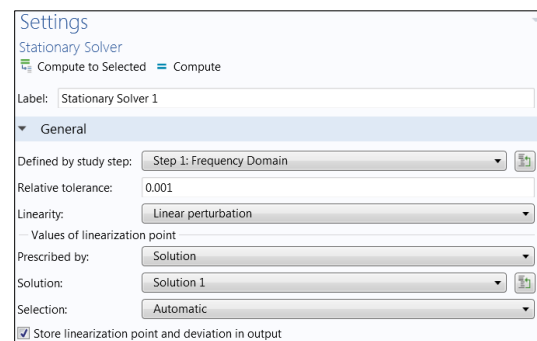

Figure 11. Solver configuration.

4.2 Measurement

The blocked coil impedance was measured with a set-up built by B&W. It uses a frequency sweep [6] and measures the impedance of the system. Note that a sensing wire was connected at the terminals of the speaker in order to get rid of the residual impedance of the cable. The tensile test machine was used to control the position of the voice coil.

- **Setup**

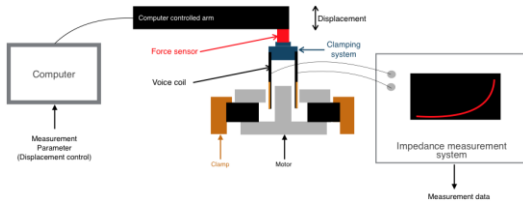

Figure 12.

4.3 Results

- **Eddy currents**

In this section, the induced current density in the top plate is displayed for two different configurations (at three different frequency): with and without zinc plating (the domain on the left represents the voice coil).

40 Hz:

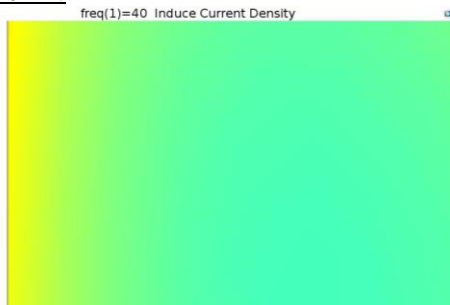

Figure 13. 40 Hz – without plating



Figure 14. 40 Hz – with plating

4000 Hz:

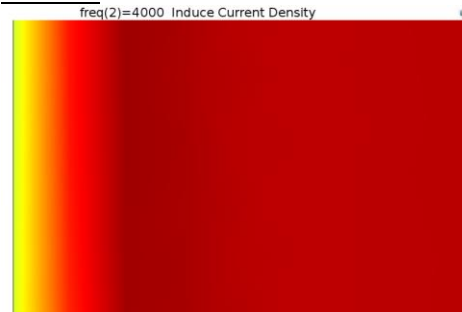

Figure 15. 4000 Hz – without plating



Figure 16. 4000 Hz – with plating

10000Hz:

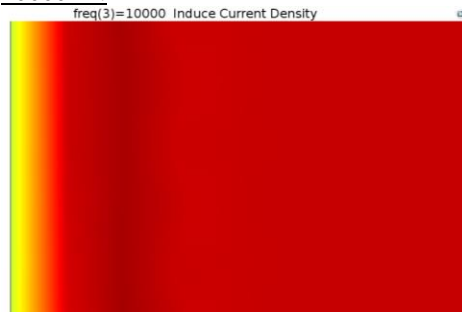

Figure 17. 10000 Hz – without plating

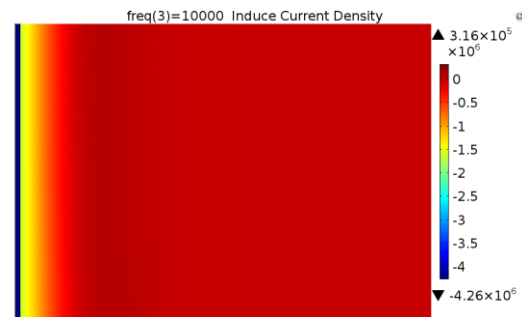

Figure 18. 10000 Hz – with plating

The difference between the two configurations is visible: when the zinc plating is present, due to the high electrical conductivity of the material and its diamagnetic properties, higher currents are flowing in the plating, but similar currents are flowing in the iron.

- **Blocked impedance measurement: mechanical artefacts.**

Figure 19 shows the results of the blocked impedance measurement. On the raw measurement, several resonances are noticeable. These were due to mechanical resonances in the clamping system and the voice coil assembly. In order to compare fairly the measurement to the model, the data has been post processed on Matlab and the resonances removed.

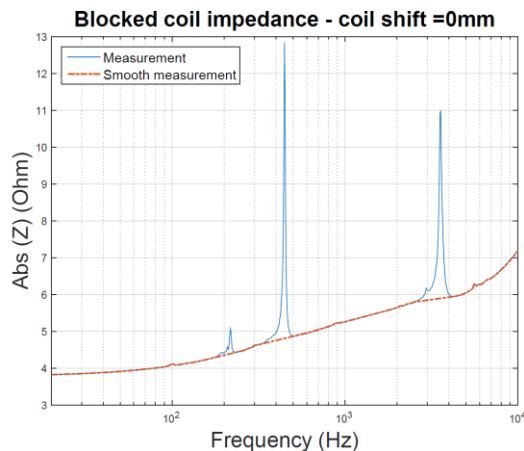

Figure 19. Measured impedance – raw/interpolated

Remark: A way to measure the blocked impedance without these resonances would be to fill the air gap, with the coil at the right position, with epoxy resin. But this would result in a huge number of prototypes to perform measurements at several coil displacements.

Remark: in the two following sections the model was solved excluding the copper cap from the physics in order to highlight the influence of the plating. The very high conductivity and relative high thickness of the copper cap would make most of the eddy currents to flow in the cap, masking the current distribution in the iron. This is at the same time a worst case scenario to assess the impact of the plating. The results are compared for a displacement of -10 mm which proved to be the one with the largest difference.

- **Blocked impedance: Mesh influence**

Here the model, without the zinc plating, was solved for two different configurations. First the mesh was set according to the dimension mentioned in **table.1**. Then the mesh was refined in order to resolve the skin depth at the highest frequency of interest (refer to the boundary layer mesh described in **section 4.1 – Meshing**).

At 10 kHz, for a displacement of -10 mm the difference between the two models is 3%. Concerning the computation time, the first mesh option has been solved for 9094 DOF at 61 frequencies and the computation time per solution is 0.2 second.

The second refined mesh has been solved for 110089 DOF at 61 frequencies and the computation time per solution is 2 second.

- **Blocked impedance: Zinc plating**

The model was solved for two different configurations. First the plating was modelled assigning Zinc properties to a thin layer around the external boundaries of each iron domain surrounding the voice coil. Then the same geometry was solved for assigning Iron properties to the thin layer. In both cases the mesh was set in order to resolve the skin depth at the highest frequency of interest (refer to the boundary layer mesh described in **section 4.1 – Meshing**).

At 10 kHz, for a displacement of -10 mm the difference between the two models is 4.7%.

The computation time was the same as the above refined mesh.

For the comparison with the measurement the model without any plating (and thus the coarser mesh of the magnetostatic case) was used because of the small error and the clear advantage in terms of DOF and computation time.

- **Blocked impedance: comparison with measured impedance**

The measurement (tensile test) and the simulation results (without plating) are compared in figure 18.

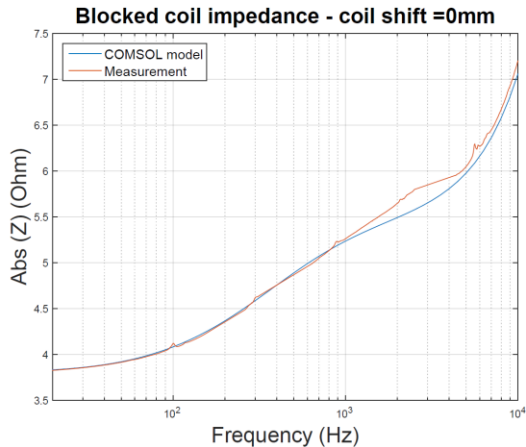

Figure 20. Blocked impedance - Comparison model/measurement.

The error at 10 kHz is 1.9%.

The model and the measurement are matching within an error of 4 % within the frequency range under study.

The difference at 3 kHz could be due to a low Q mechanical resonance not filtered out or electromagnetic effects not included in the model.

- **Blocked impedance: -5mm**

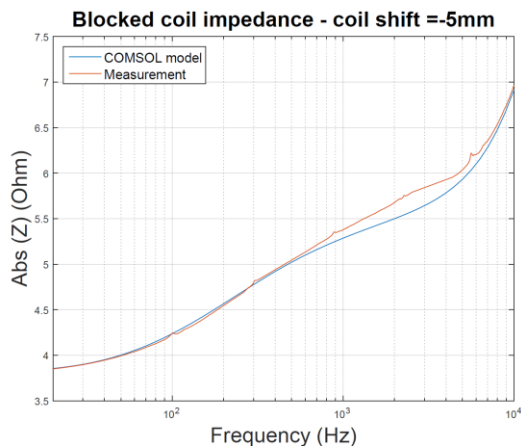

Figure 21. Blocked impedance: -5mm

- **Blocked impedance: -10mm**

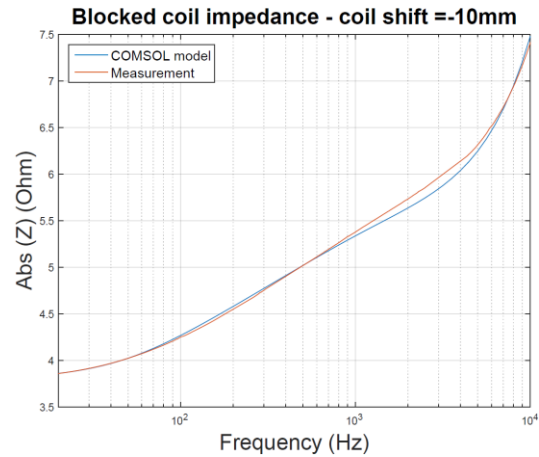

Figure 22. Blocked impedance: -10mm

The curves for 5mm and 10mm displacement aren't displayed because the results were overlaying perfectly (it's basically the impedance of a coil in 'almost' free air).

5. Conclusion

Both COMSOL and FEMM gave very accurate results for the flux density and the force factor. COMSOL has proven to be a little faster and the possibility to implement a parameterized geometry is probably better suited for a development work and automatic optimization.

For the blocked impedance, COMSOL results were well within a 4% error across the entire excursion, thus the model is perfectly suitable for development and optimization work. The use of a finer mesh and adding the zinc plating don't have a major impact on the results for the motor topology showed in this paper. For topologies using neodymium discs inside the voice coil (typical for many other drive units), ignoring the nickel plating applied to protect the sintered NdFeB magnets results in a blocked impedance magnitude error of about 8%.

6. References

[1] Lorenzo Bortot, *Optimization of demodulation rings in professional loudspeakers*, MSc Thesis, Università degli Studi di Padova (2013).

[2] Mattia Cobianchi, *High frequency drive units modelling through finite element analysis*, MSc Thesis, Università Roma Tre (2005).

[3] COMSOL Inc, *COMSOL Multiphysics – Reference Manual* (2015).

[4] David Meeker, *Finite Element Method Magnetic –User’s Manual* (2010).

[5] Klippel LSI Specifications
www.klippel.de/our-products/rd-system/modules/large-signal-identification.html

[6] P. Massarani S. Müller, Transfer - function measurement with sweeps, *JAES*, Vol.49, page 443 (2001).

7. Acknowledgements

We would like to thank:

-Alon Grinenko and all the Comsol support team for the help provided during this project;

-David Meeker for his help on the details of the physics formulations in FEMM;

-the Klippel support team for the useful discussions concerning the force factor polynomial fitting.

The project was part of the International Master’s Degree in ElectroAcoustics (IMDEA) powered by the Université du Maine.